

NOTES:

1 OPEN DOOR VIEW INCLUDES HINGE SPACE OFFSET.

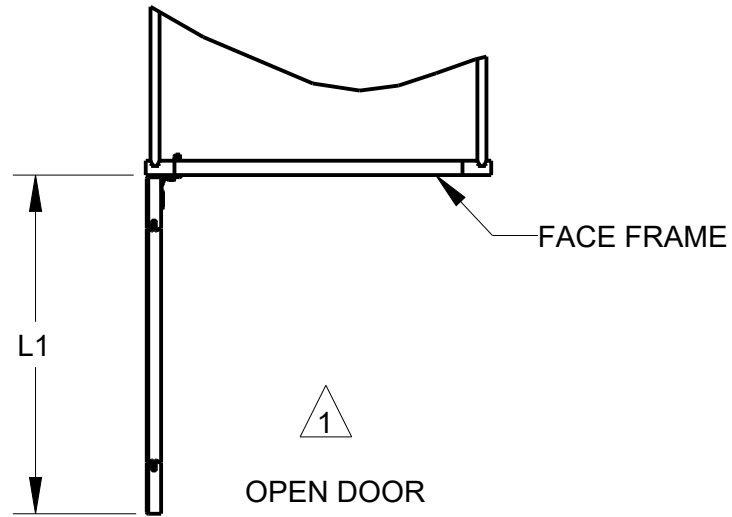
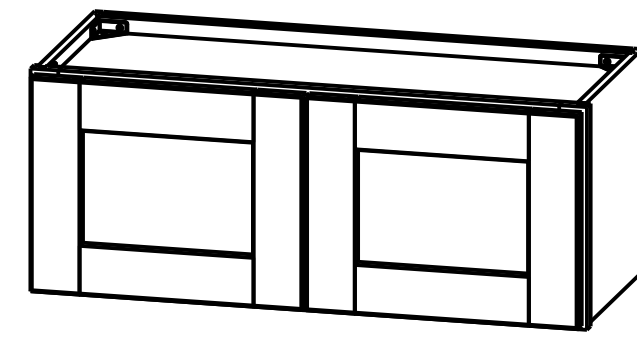
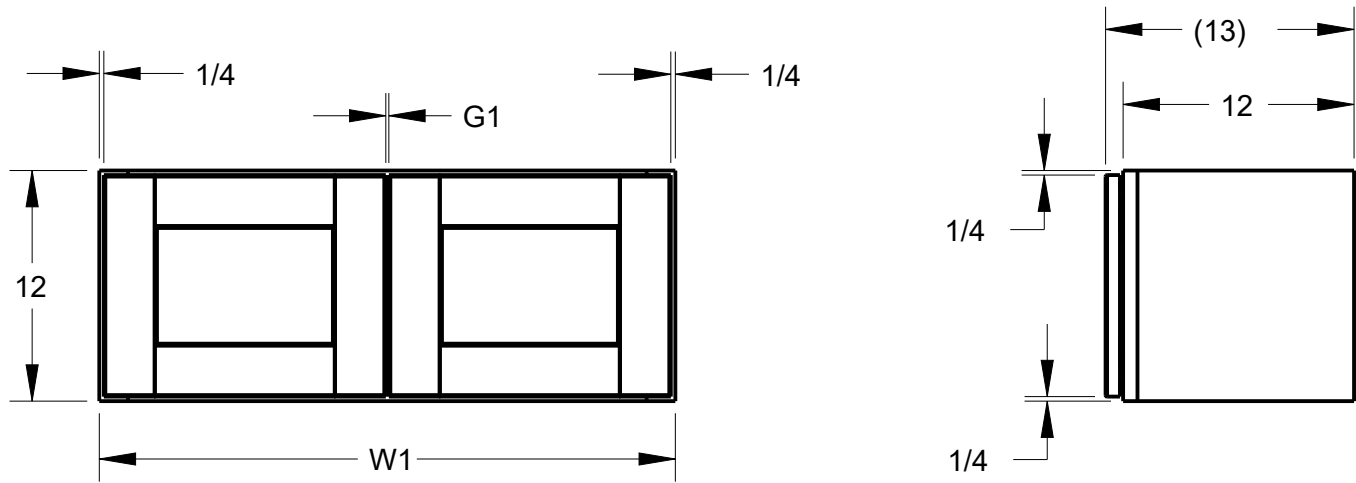

PRODUCT	W1	L1	G1	DOOR SIZE
			ROUNDED TO THE NEAREST 1/32	
W3012	30"	14 13/16"	(5/16")	14 11/16" X 11 17/32"
W3312	33"	16 5/16"	(5/16")	16 3/16" X 11 17/32"
W3612	36"	17 13/16"	(5/16")	17 11/16" X 11 17/32"
W3912	39"	19 3/16"	(15/16")	19 1/16" X 11 17/32"

THIRD ANGLE PROJECTION 		hardware resources		
MATERIAL N/A	FINISH N/A			
DRAWN BY E.GOLESTANYAN		DATE 19MAR2020		DRAWING NUMBER W3912-W3612-W3312-W3012_FULL
DESIGNED BY NORTHPOINT		DATE		
APPROVED BY GREG DAVIS		DATE 27MAR2020		REV B
SIZE A3		SCALE 0.100		SHEET 1 / 1

PRODUCT SHOWN W3012

DOCUMENT STATUS Released

HARDWARE RESOURCES RESERVES THE RIGHT TO CHANGE SPECIFICATIONS WITHOUT NOTICE. IN CASE OF A DISCREPANCY, ACTUAL PART GEOMETRY SUPERSEDES THIS DOCUMENT.

THE INFORMATION CONTAINED WITHIN THIS DRAWING IS THE SOLE PROPERTY OF HARDWARE RESOURCES INC. ANY REPRODUCTION IN PART OR WHOLE WITHOUT WRITTEN PERMISSION OF HARDWARE RESOURCES INC. IS PROHIBITED.